

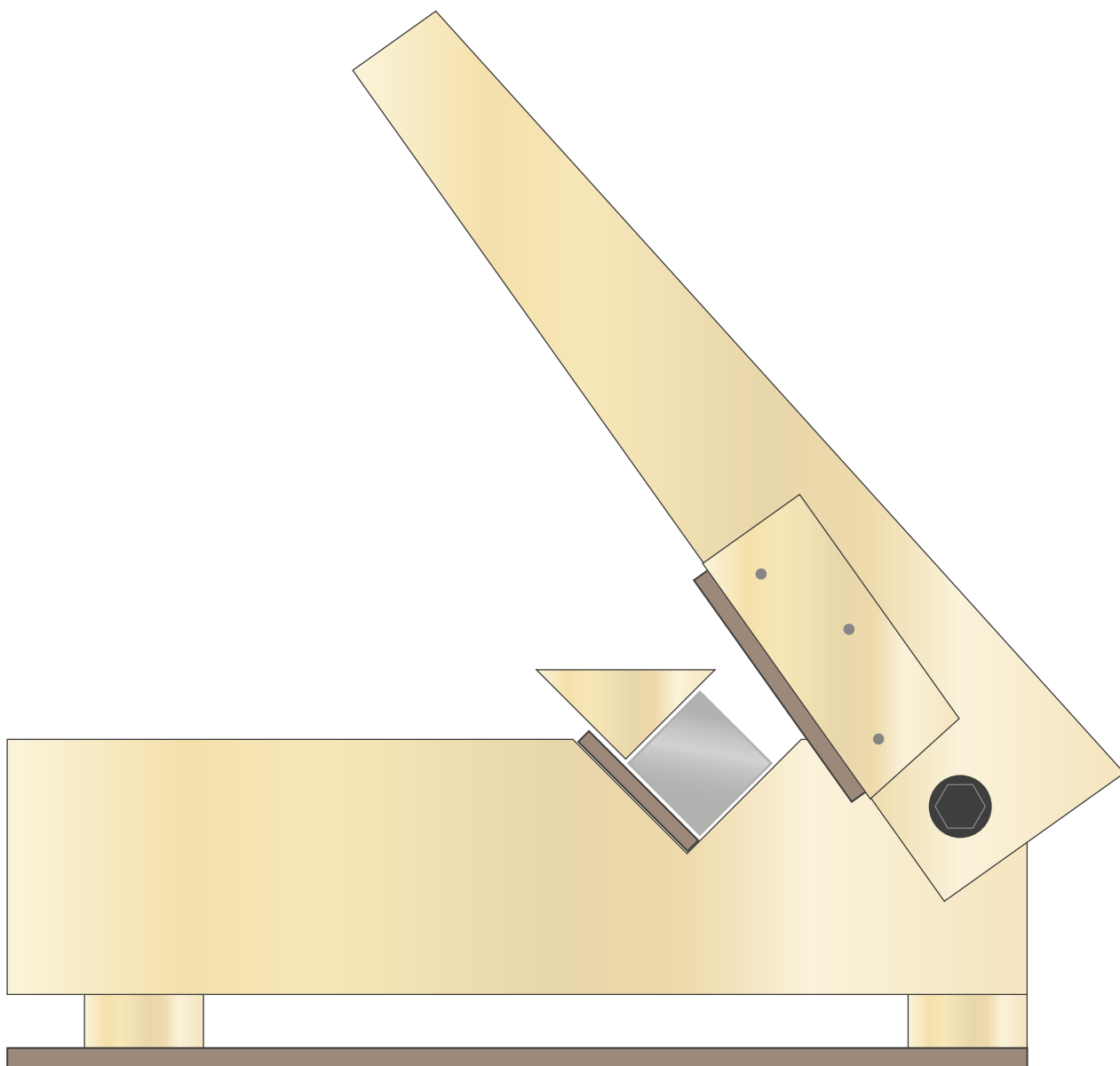

supermagnete

Magnet Separator

Construction Manual



Shopping list







Wood

- 2 x plywood 15 x 60 x 2.4 cm
- 1 x plywood 30 x 60 x 2.4 cm
- 1 x hard wood fibre building board 60 x 60 x 0.8 cm



Small hardware

(ATTENTION: Do not select ferromagnetic items)

- 13 x wood screw stainless steel (flat head) - 4.5 x 45 mm
 (H)
- 12 x wood screw stainless steel (flat head) - 3.5 x 35 mm
 (I)
- 1 x hexagon screw (or similar) stainless steel - M8 x 100 mm
 (J)
- 1 x lock nut - M8
 (K)
- 2 x washer - M8
 (L)

Miscellaneous

- 1 x metal tape self-adhesive - approx. 1 m ([M-FERROTAPE](#)) (M)
- 1 x UHU Max Repair adhesive ([WS-ADH-01](#)) (N)
- 1 x soft sponge approx. 20 x 15 x 5 cm (O)



Tools

- 1 x pencil
- 1 x yardstick/measuring unit
- 1 x protective gloves
- 1 x protective glasses
- 2 x screw clamp (15-30 cm)
- 1 x jig saw with saw blade for wood (alternative: hand saw)
- 1 x cordless drill with the following attachments:
 - Wood driller 8 mm (for large hole)
 - Wood driller 6 mm (to countersink the screw heads)
 - Wood driller 5 mm (to countersink the screw heads)
 - Bits: suitable for the selected wood screws
- 1 x coarse sand paper
- 1 x fine sand paper
- 1 x scissors



1



60 cm

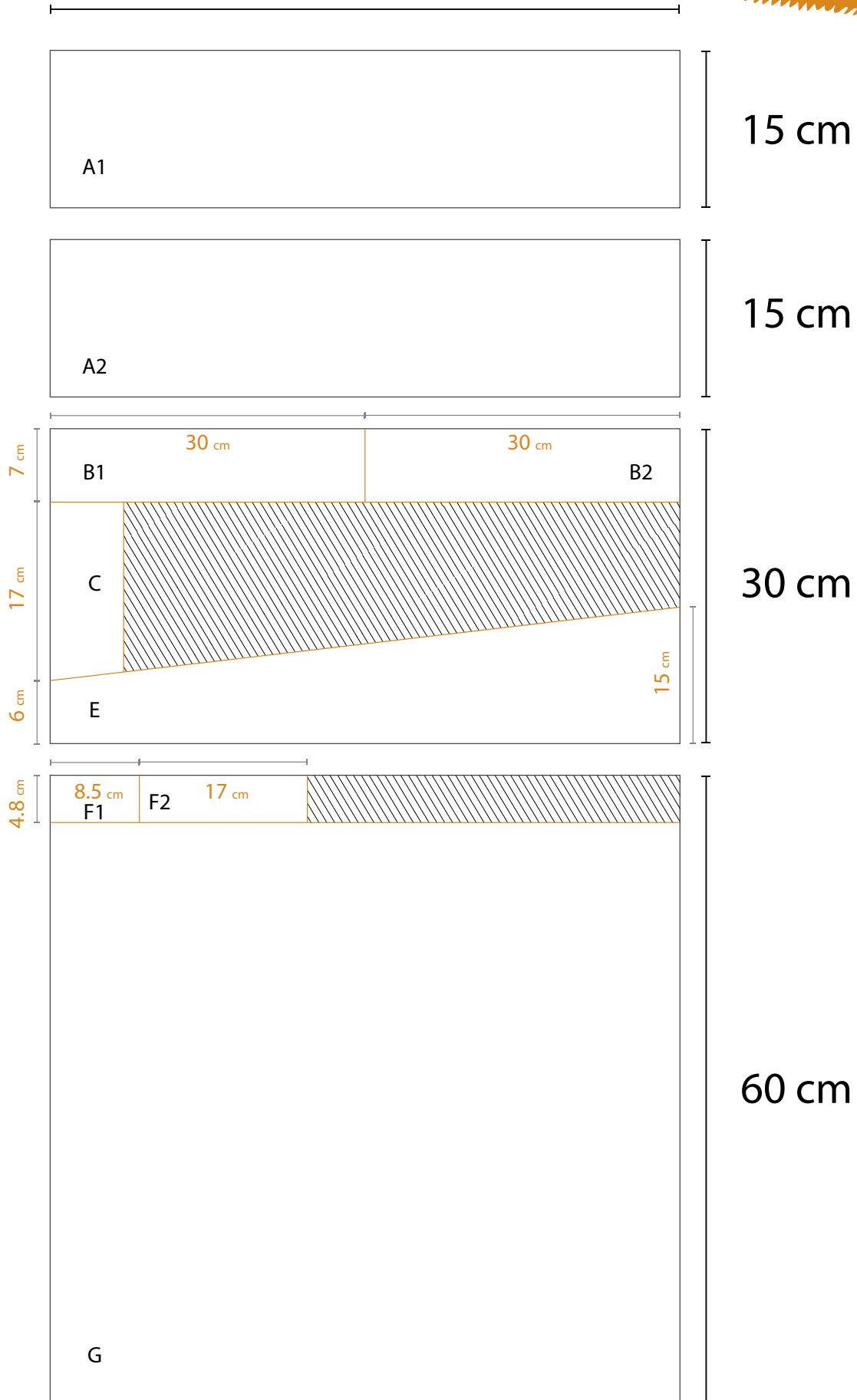
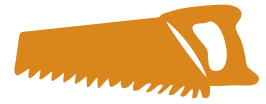

2

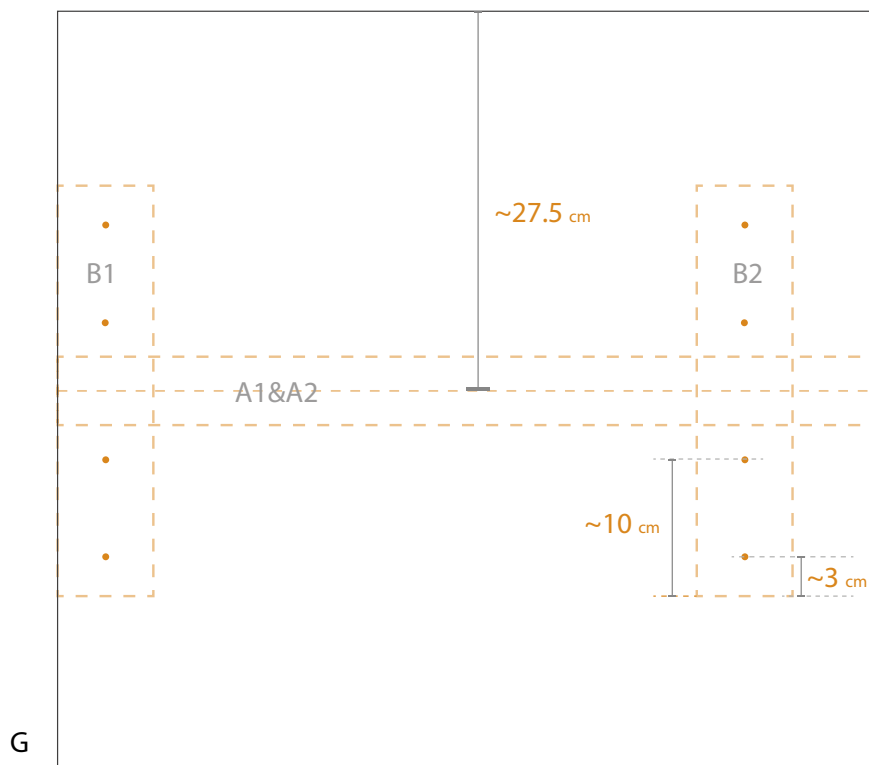
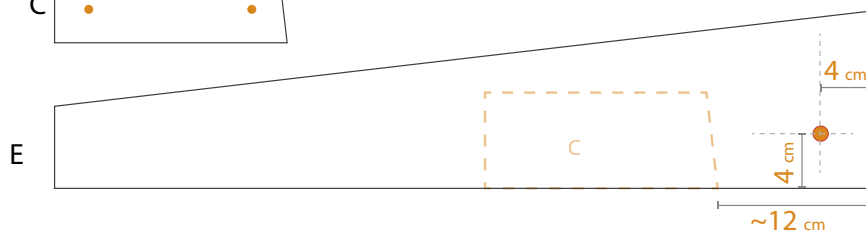
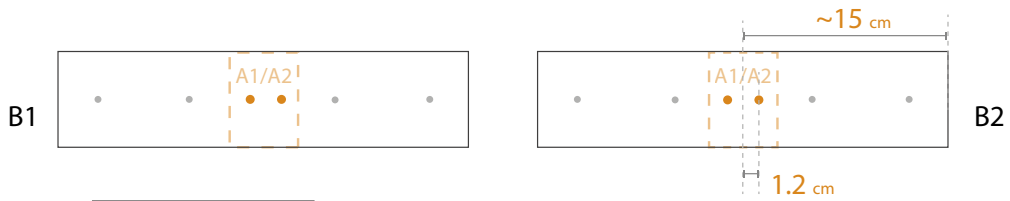
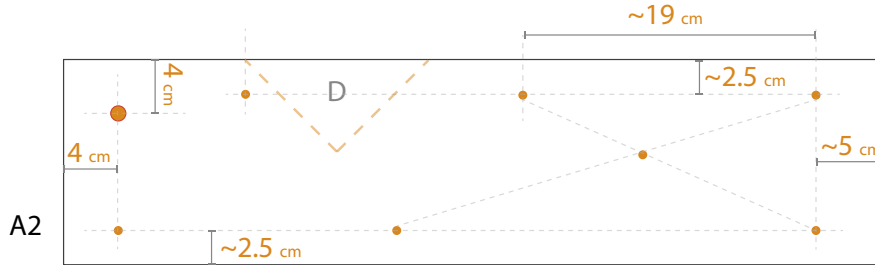
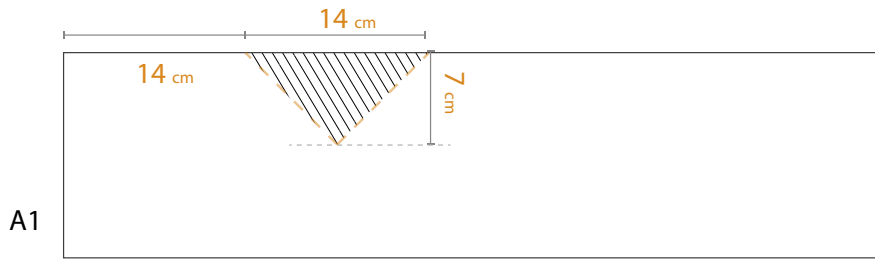



3

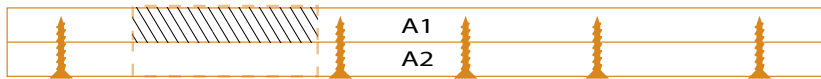
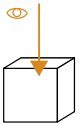
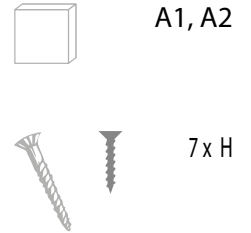
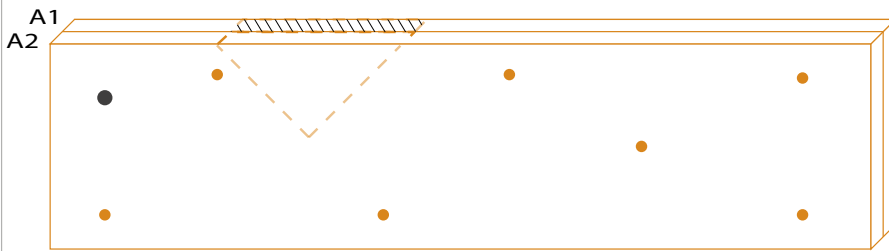
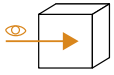

4

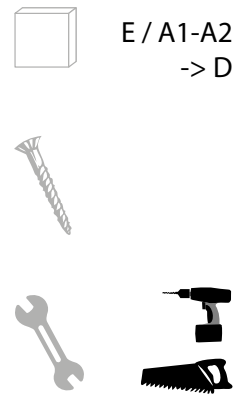
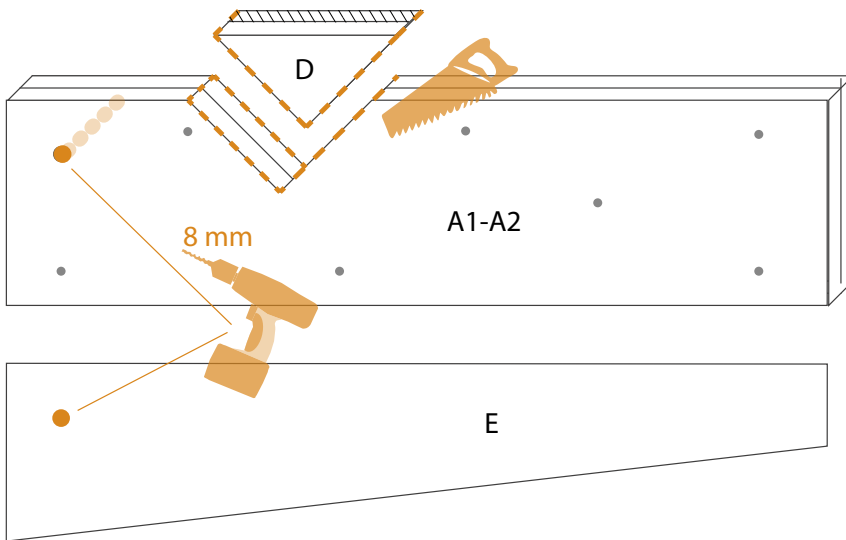
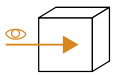

5

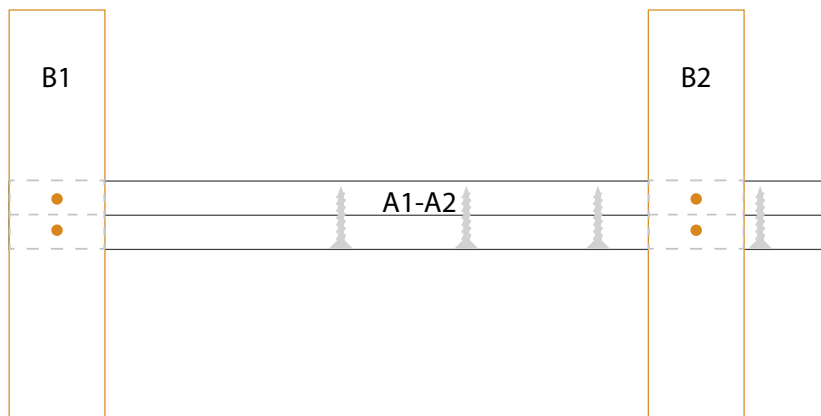
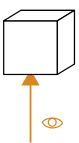
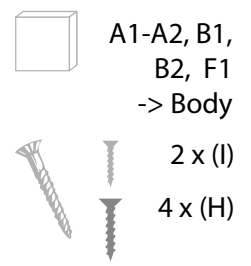
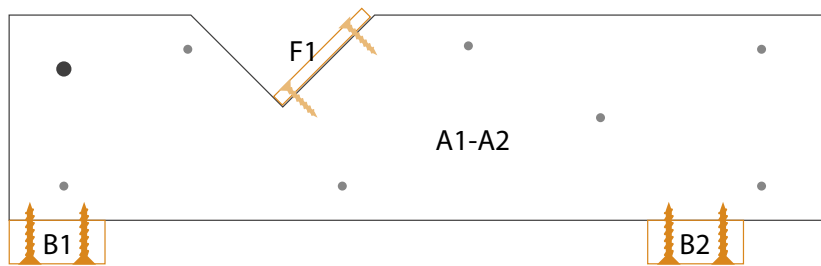
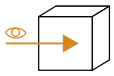

6

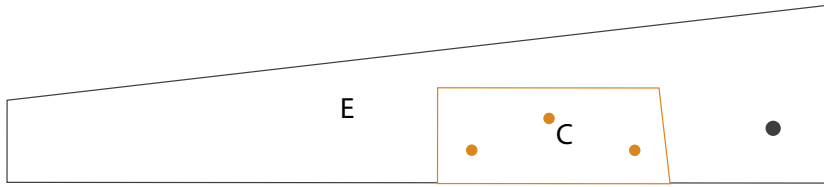
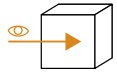

C, E



3 x (H)

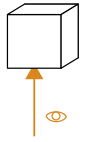

7

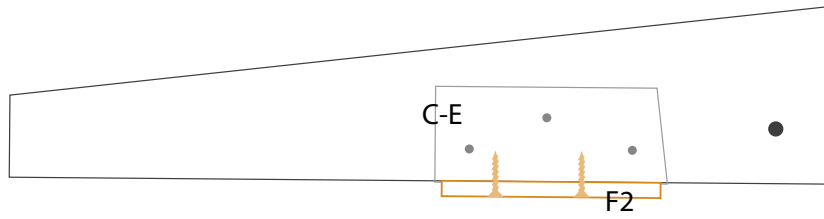
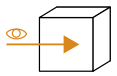

C-E, F2
-> Arm



2 x (I)



8

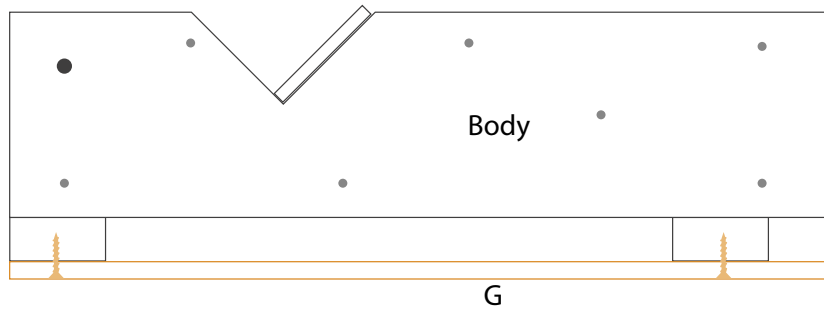
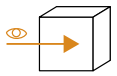

Body, G



8 x (I)

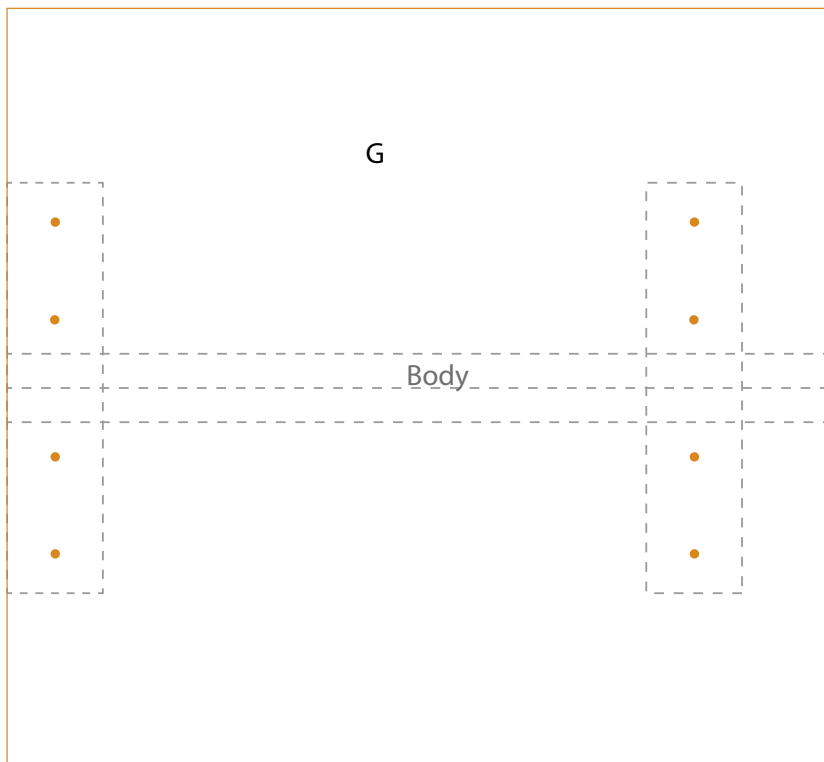
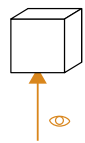

9

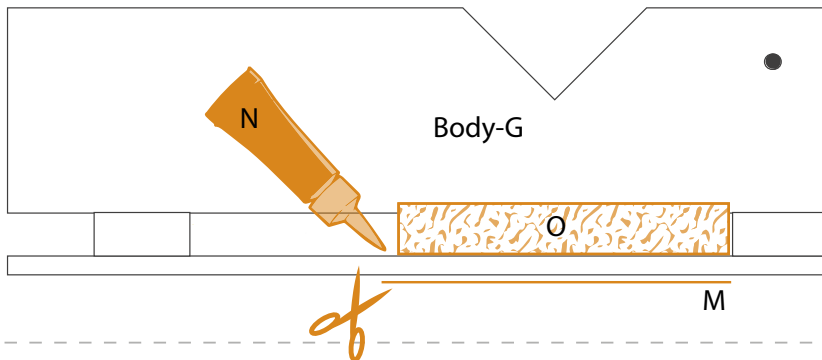

Body-G



1 x (O)

1 x (M)

1 x (N)

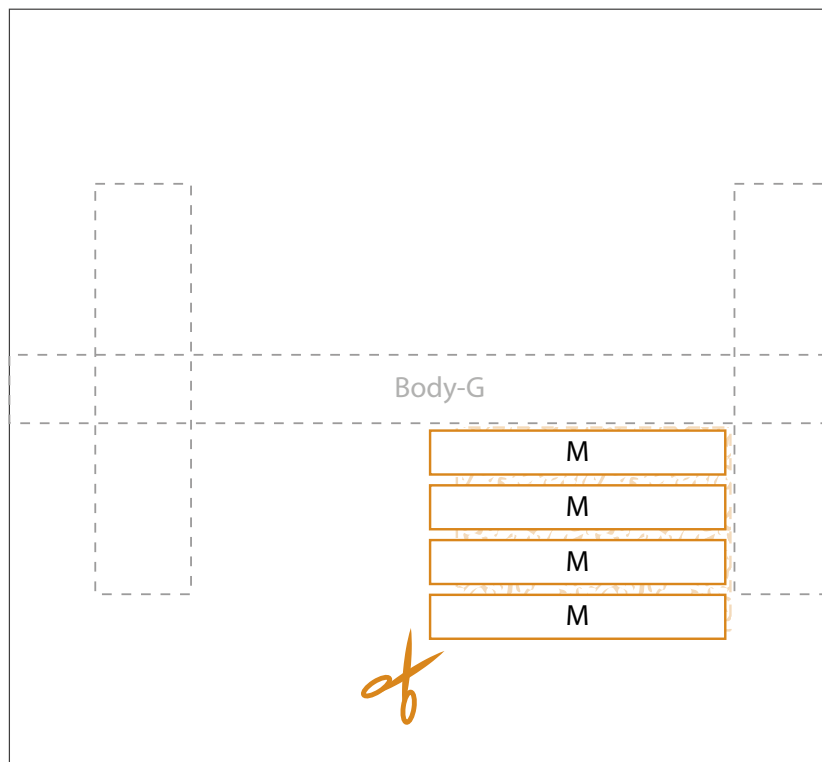
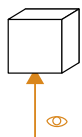

10

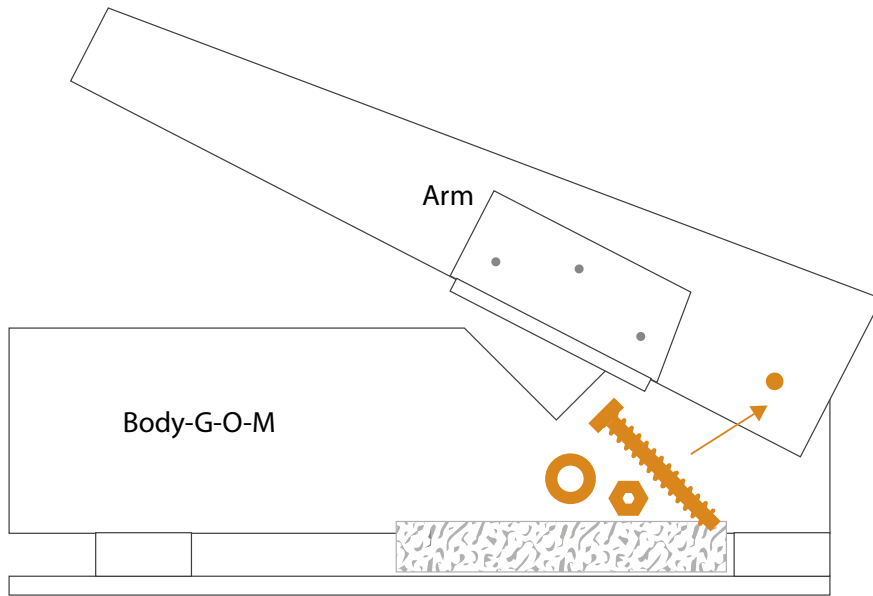
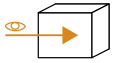

 Body-G-O-M,
Arm

 1 x (K)
 2 x (L)

 1 x (J)

